

R-Seal

Rigid Envelope System Insulation Guide



Pacific Insulation Products

"TOMORROW'S NEEDS, TODAY'S PRODUCTS, SERVICE NOW"



Pacific Insulation Products

Pacific Insulation Products serves the Pre-Engineered Metal Building market and commercial construction market throughout North America.

We are an innovative company developing new products to meet today's stringent building envelope performance requirements.

Our primary objective is to provide the best finished envelope insulation system. We achieve this by using a unique blend of skills and experience from metal building erection, product manufacturing, and sales fields.

We become part of your team and work closely with building manufacturers, dealers, and erectors, to ensure quality project delivery.

Visit Our Website:
pacificinsulationproducts.com

R-Seal

Services

Accessories

Insulation Guides

Quote forms

FAQ

And More



R-Seal: Rigid Envelope System

"TOMORROW'S NEEDS,
TODAY'S PRODUCTS, SERVICE NOW"

Description:

Pacific Insulation Products proprietary rigid polyurethane insulation (R-Seal), is specifically designed and produced for metal building erectors. R-Seal provides the most economical and lowest installed cost method to meet; current energy code requirements for continuous insulation, air barrier requirements, and higher installed R-Values.

With the highest R-Value per inch in the industry, custom lengths, integral tape tabs, and individual building detailing; this product installs as fast as blanket insulation with higher installed R-Values than Banded Liner Systems can achieve alone.

Applications:

In addition to meeting the energy code and air barrier requirements for new construction of Pre-Engineered Metal Buildings, R-Seal is a great solution for retrofits of existing buildings.

With proper trim and detailing, the durable surface is also a suitable application for Walk-In Coolers. The boards are able to be fastened directly to the interior of Metal Building framing using a thermally broken fastener.

Products			
R-Value	U-Value	Thickness (inches)	Joint Style
R-15	0.064	2.0"	Butt
R-18.75	0.053	2.5"	T & G / Butt
R-22.5	0.044	3.0"	T & G / Butt
R-30	0.031	4.0"	Butt/Shiplap
R-37.5	0.027	5.0"	T & G / Butt

Tolerances subject to normal manufacturing variations.

Technical Data	
*Fire hazard classification: (Composite: Facing/Foam Core/Facing)	Flame Spread <20 Smoke Developed <150
Full Scale Fire Test: (Tested to IBC Section 2603.9 standards)	UL 1715 PASS CAN/ULC-S138 PASS
Air Barrier Performance:	Component: Less than 0.004CFM Assembly: Less than 0.04CFM Building: Less than 0.4CFM

*The above flame spread rating was determined in accordance with ASTM E-84. This standard is used solely to measure and describe properties of materials and products in response to heat and flame under controlled laboratory conditions. This numerical flame spread is not intended to reflect hazards presented by this or any other material under actual fire conditions.

Comparison of R-Seal Versus Common Polyisocyanurate Rigid Boards

Attribute	R-Seal Board	Polyisocyanurate Board
R Value Per Inch	7.5	6.5
Compressive Strength	31psi	20psi
Density	2.2-2.5 lb/sq ft	2.0 lb/sq ft
Dimensional Stability	Good	Fair
Exposure Rated Foam	Yes	Thermax Only
Custom Lengths	Yes	No
Finished Seams	Yes	Requires Additional Products & Installation
Installation Details	Yes	Not Available

R-Seal: System Fundamentals

For new construction R-Seal installs in a very similar manner to traditional laminated Metal Building Insulation.

Preparation:

When the building manufacturer is aware that rigid foam is going to be used on the building envelope, they will detail the trim package just as would be done with Insulated Metal Panels. This ensuring a proper flashing package for the thickness of rigid board being supplied. Longer fasteners need to be specified for the through fastened wall and/or roof sheeting, and proper considerations for sheer need to be made. For Standing Seam Roofs a bearing plate style clip should be specified.

Wall Installation:

The base trim and/or the concrete needs to be configured to support the bottom of the panel. Double faced tape at the eave and at the base is used to hold the panel in place prior to wall sheeting just as when installing traditional “blanket” MBI. The panel should also be fastened at the top and bottom with two screws. If wind is an issue, a self-tapping screw with a fender washer can be used at the intermediate girts for additional support.

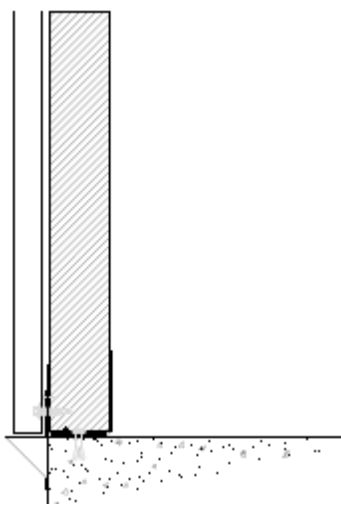

Base Detail

Metal and trim are for reference only, not by PIP.

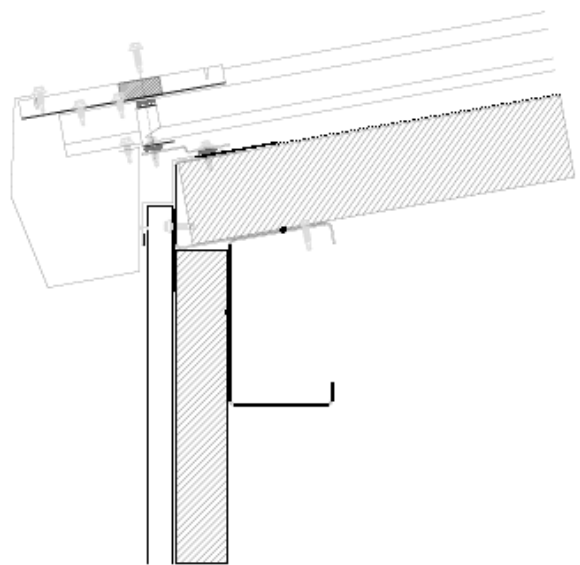

Eave Detail

Metal and trim are for reference only, not by PIP.

Wall Installation:

For walls less than 24' the panel is typically supplied in one piece from base to eave. For taller eave heights the panel will be detailed to stop at a girt line. It is recommended that an "L" angle be attached to this girt to properly support the edges of the upper and lower panel.

Trimming around the windows and doors can be done with a reciprocating saw as the edges will be covered with the Metal Building trim package.

Roof Installation:

The bottom edge of the roof panels are held in place with framing "J" supplied by the Metal Building Manufacturer, or as detailed by Metal Building Manufacturer. As with the wall panels, the roof can be temporarily held in place with double faced tape until the roof is sheeted. The roof panels are typically supplied in 25' or shorter lengths (typically whatever length spans four or five purlins). They will break on a purlin and it is recommended that an "L" angle be attached to the purlins to properly support the edges of the upper and lower panel.

At the ridge, it is optional to use a 6" piece of sheet stock bent to the roof pitch to secure the panel joint at the ridge. Sheet stock will not be supplied by PIP, it will need to be provided by Metal Building Manufacturer. Or the ridge to be finished as detailed by Metal Building Manufacturer.

Roof and wall dings can be repaired with a readily available can of spray foam and supplied patch tape.

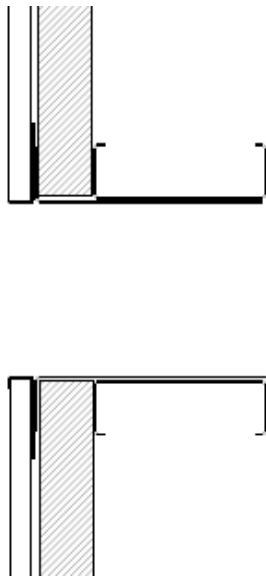

Framing Opening Detail

Metal and trim are for reference only, not by PIP.

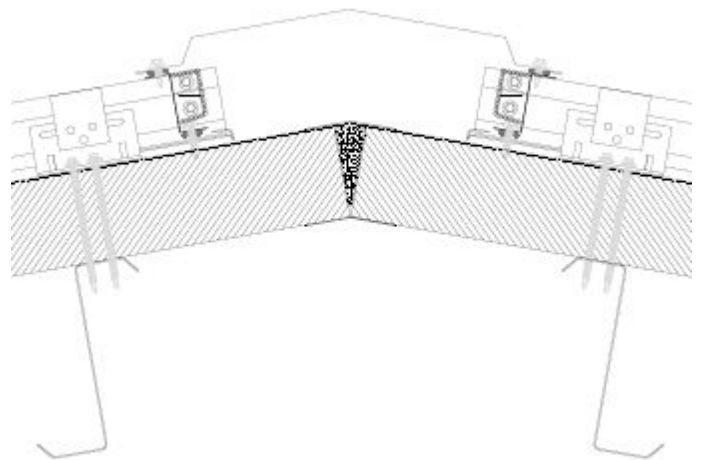

Ridge Detail

Metal and trim are for reference only, not by PIP.

R-Seal: Applications

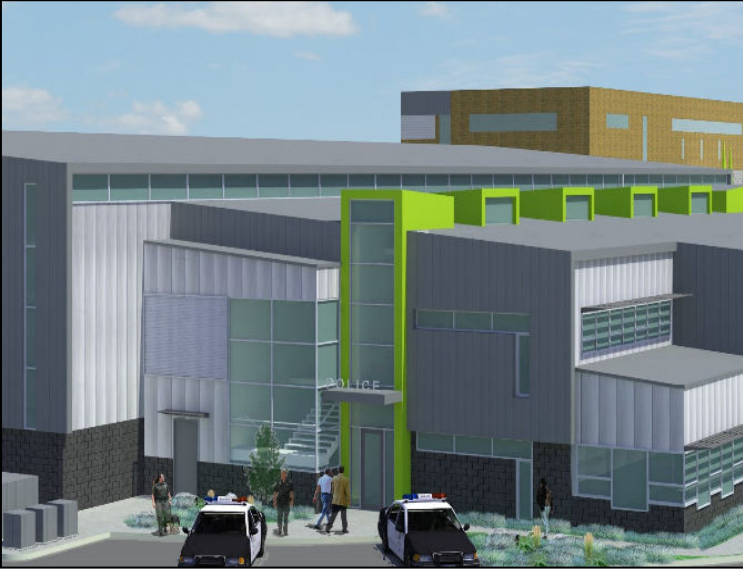

R-Seal's applications and uses span many di

Warehouses

Manufacturing Plants

Distribution Facilities

Aerospace & Aviation

Agricultural Buildings

Walk-In Coolers

Food Processing Facilities

Wineries

Public Works

Military Build

Federal & Sta

Municipal Bu

R-Seal: Applications

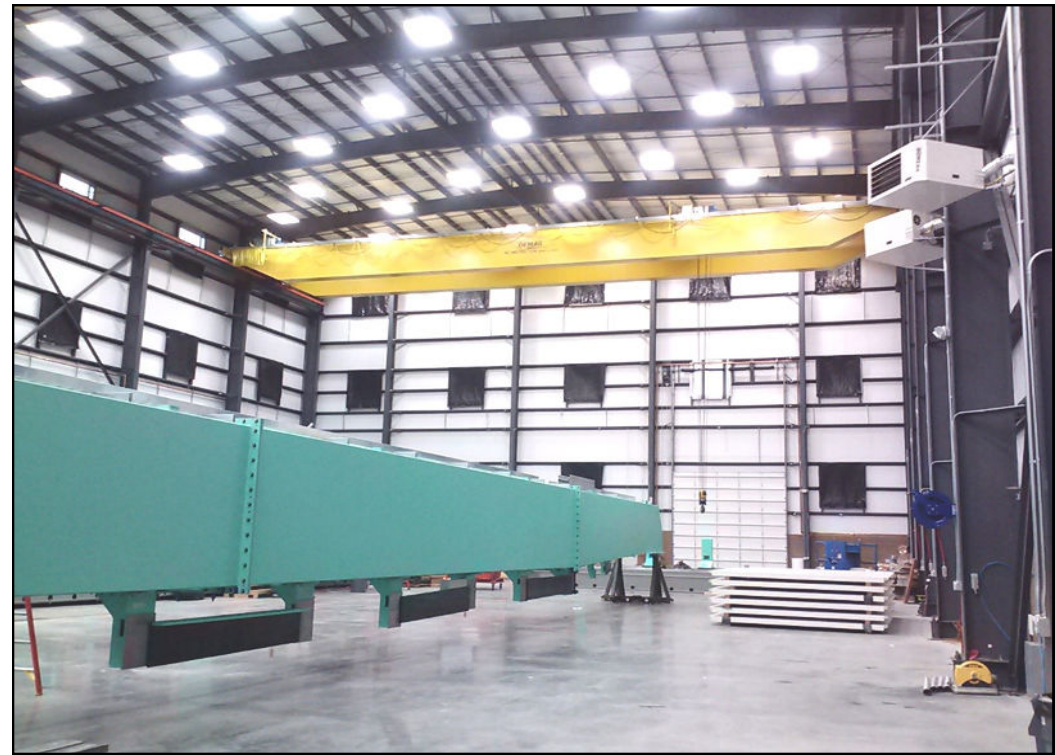

Different types of metal building construction

Warehouses & Sanitation

Schools & Universities

Offices & Retail Stores

Manufacturing Buildings

Community Centers

Showrooms

Event Facilities

Convention Centers

Athletic Centers

Storage Buildings

Worship Facilities

And Many More...

R-Seal: Air Barrier Applications

Air Barriers are being specified more and more frequently in order to comply with USACE (US Army Corps of Engineers), IGCC (International Green Conservation Code), and NZEB (Net Zero Energy Buildings). A highly insulated and air tight building envelope is the first step to improving a building's energy efficiency.

Metal buildings face significant challenges when required to pass the Whole Building Air Barrier Pressure Test. R-Seal overcomes these challenges by placing the insulation on the exterior of the building envelope in a continuous layer that is uninterrupted by framing. That vastly simplifies the detailing required to seal correctly.

Each building presents unique challenges. R-Seal insulation packages allow buildings to meet air barrier requirements by simply adding non-skinning butyl at the panel laps, panel joints, as well as at the base and eave transitions.

Pacific Insulation Products works with the building designer, manufacturer, and the erector to make sure that your Pre-Engineered Metal Building Air Barrier projects are successful. We can also provide "Pre-Testing" services to verify that the building meets the testing required prior to sub-trades commencing their work.

Building Performance Testing/Benchmarking

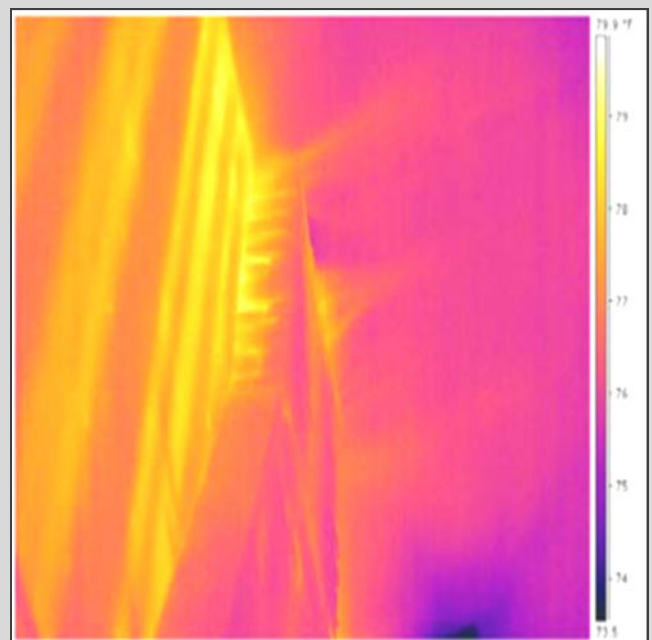

R-Seal: Approval Shop Drawings

"TOMORROW'S NEEDS,
TODAY'S PRODUCTS, SERVICE NOW"

All R-Seal® projects come with custom layouts which minimize the waste typical of traditional 4x8 sheets of rigid insulation.

Layout drawings are supplied to match the PEMB gridlines for an easy project layout.

PACIFIC INSULATION PRODUCTS
APPROVAL DRAWINGS

PROJECT NUMBER: 0000
PROJECT NAME: APPROVAL
PROJECT ADDRESS: 123456789
CUSTOMER: ABC COMPANY, INC.
DATE: 1/1/2020

THIS DRAWING IS FOR APPROVAL ONLY. IT IS NOT TO BE USED FOR CONSTRUCTION. THE USER OF THIS DRAWING SHALL BE RESPONSIBLE FOR OBTAINING ALL NECESSARY PERMITS AND APPROVALS FROM THE LOCAL BUILDING DEPARTMENT. THE USER SHALL BE RESPONSIBLE FOR OBTAINING ALL NECESSARY PERMITS AND APPROVALS FROM THE LOCAL BUILDING DEPARTMENT. THE USER SHALL BE RESPONSIBLE FOR OBTAINING ALL NECESSARY PERMITS AND APPROVALS FROM THE LOCAL BUILDING DEPARTMENT.

NO.	REV.	DATE	BY	APP.	DESCRIPTION
1	0	1/1/2020			ISSUED FOR APPROVAL

PACIFIC INSULATION PRODUCTS

PROJECT NUMBER: 0000
PROJECT NAME: APPROVAL
PROJECT ADDRESS: 123456789
CUSTOMER: ABC COMPANY, INC.
DATE: 1/1/2020

R-SEAL ELEVATION @ SWC

R-SEAL ELEVATION @ SWA

NO.	REV.	DATE	BY	APP.	DESCRIPTION
1	0	1/1/2020			ISSUED FOR APPROVAL

PACIFIC INSULATION PRODUCTS

PROJECT NUMBER: 0000
PROJECT NAME: APPROVAL
PROJECT ADDRESS: 123456789
CUSTOMER: ABC COMPANY, INC.
DATE: 1/1/2020

R-SEAL ROOF SCHEDULE

NO.	NO. OF PANELS	NO. OF JOINTS	NO. OF TABS	NO. OF TABS PER JOINT	NO. OF TABS PER PANEL
1	10	9	18	2	2
2	10	9	18	2	2
3	10	9	18	2	2
4	10	9	18	2	2
5	10	9	18	2	2
6	10	9	18	2	2
7	10	9	18	2	2
8	10	9	18	2	2
9	10	9	18	2	2
10	10	9	18	2	2

PACIFIC INSULATION PRODUCTS

PROJECT NUMBER: 0000
PROJECT NAME: APPROVAL
PROJECT ADDRESS: 123456789
CUSTOMER: ABC COMPANY, INC.
DATE: 1/1/2020

PANEL END LAP, ROOF

ROOF TO WALL TRANSITION

PANEL END JOINT, RIDGE

BASE CHANNEL

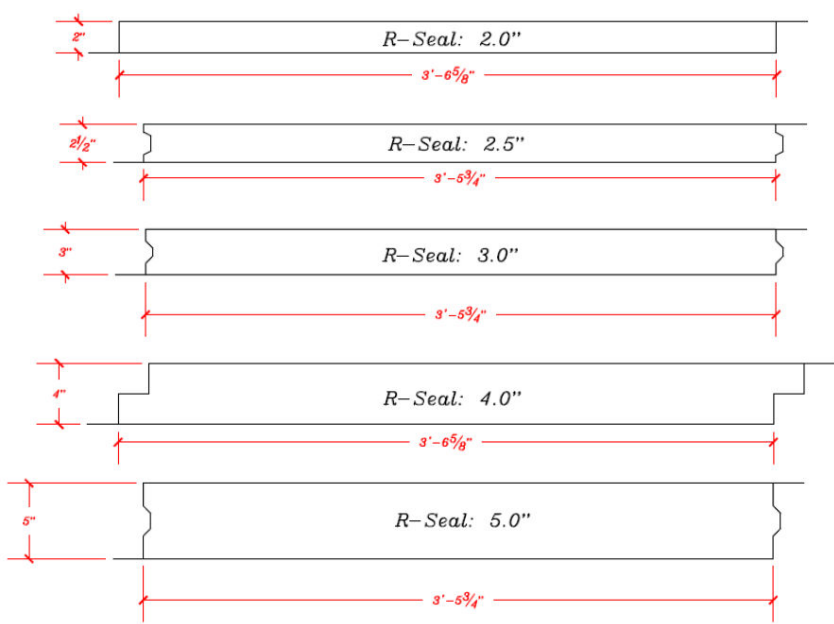

R-Seal® profiles

PACIFIC INSULATION PRODUCTS PO BOX 12884 EVANSTON, ILLINOIS 60125 PHONE 877-300-3791 FAX 430-925-7272	
CUSTOMER: John Doe 123 Main Street Mesa, AZ 85201	SURFACE B.I.B.N CHARACTERISTICS: ASTM E84 Less than 20/150
PROJECT: John Doe Shop Building 100 West Parkway Phoenix, AZ 85001	
PRODUCT: R-Seal: R30 Double Seal Tabs	
PRODUCT DETAILS: 10 Panel @ 20' X 40' X 4"	10

Tab on the end of each R-Seal® bundle



R-Seal® panel bundles

R-Seal: Material Data Sheet

PHYSICAL PROPERTIES	ASTM METHOD	ENGLISH UNITS	VALUES
COMPOSITE			
SURFACE BURNING FLAME SPREAD UP TO 6" SMOKE GEN. UP TO 6"	E-84 CAN/ULC S102		20 150
R-VALUE (PER INCH) 75°F MEAN	C-518	hr·ft ² ·°F/Btu	7.5
CORE			
DENSITY	D-632	lb/ft ³	2.25 +/- .25
COMPRESSIVE STRENGTH -PARALLEL -PERPENDICULAR	D-1621	lb/in ²	40 23
COMPRESSIVE MODULUS -PARALLEL -PERPENDICULAR	D-1621	lb/in ²	1400 266
K-FACTOR	C-518	Btu·in/hr·ft ² ·°F	0.137
WATER VAPOR TRANSMIT ION	E-96	perm-inch	2.27
WATER ABSORPTION (96hr IMMERSION)	D-2842	%	1.66
CLOSED CELL	D-2856	%CLOSED	87
NBS SMOKE DENSITY	E-662		220
DIMENSIONAL STABILITY			
100°F / 100% RH @ 28 DAYS		% CHANGE	-0.461
158°F / 100% RH 28 DAY	D-2126	% CHANGE	1.806
158°F 28 DAY		% CHANGE	-0.941
200°F 28 DAY		% CHANGE	-0.569
-20°F 7 DAY		% CHANGE	-0.178
FULL SCALE FIRE TEST			
(Tested to IBC Section 2603.9 standards)	UL 1715 CAN/ULC-S138		PASS PASS
MINIMUM SELF-IGNITION TEMP	D-1929	°F	932
MINIMUM FLASH-IGNITION TEMP	D-929	°F	698
TENSILE AND BURSTING PROPERTIES			
TENSILE STRENGTH	C-1136	lb/in ²	100
BURSTING STRENGTH	D-774	lb/in ²	35
PUNCTURE RESISTAN	C-1136	beach units	
THICKNESS	MICROMETER	in	0.007
PERMEANCE	E-96 (PROCEDURE A)	perm	0.02
MOLD RESISTANCE	C-665/C-1338		NO GROWTH
EMISSIVITY	E-408		0.03 - 0.8
SURFACE BURNING			
FLAME SPREAD SMOKE GENERATON	E-84		10 35

R-Seal: Specification Guide

RIGID AIR/VAPOR BARRIER INSULATION PANEL: Rigid closed cell foam board insulation panel consisting of a polyurethane foam core laminated between fiber-reinforced polypropylene.

1. Manufacturer/Product: Pacific Insulation Products, R-SEAL.
2. Board Edges:
 - A) Tongue and Groove
 - B) Butt Joint
3. Facers: PS (Polypropylene/Scrim) bonded to rigid foam.
4. Tape Tab: Pacific Insulation products primary and/or secondary tape tab/tabs for air tight seal of air/vapor barrier seams.
5. The panel core shall have a flame spread no greater than 25 and a smoke development no greater than 150 when tested in accordance with ASTM E 84 test method.
6. The panel shall comply with chapter 26 of the 2009 IBC
7. Compressive Strength (Core) Per ASTM D1621:
 - A) Parallel: 31 psi
 - B) Perpendicular: 16 psi
8. Compressive Modulus (Core) Per ASTM D1621:
 - A) Parallel: 721 psi
 - B) Perpendicular: 433 psi
9. Water Absorption (Core) Per ASTM D2842: 1.6%
10. Dimensional Stability (Core):

100°F/100% RH @ 28 days	0.1
158°F/100% RH @ 28 days	0.4
158°F @ 28 days	0.0
200°F @ 28 days	0.1
-20°F @ 7 days	0.3
11. Total R-Value: As indicated on drawings.
12. Air Barrier Materials Air Permeance: Not to exceed 0.004 cubic feet per minute per square foot under a pressure differential of 0.3 w.g. (1.57 psf or 75 Pa) when tested in accordance with ASTM E2178.
13. Air barrier systems shall accommodate changes in the substrate and perimeter sealing conditions.
14. Different air barrier systems shall be permanently joined together in a manner approved by both manufacturers.

Accessories:

1. Spray Foam: Spray polyurethane foam sealant as required for gap filler.
2. Butyl Sealant: Butyl rubber, non-drying, non-skinning, non-curing; typically Silkalastomer 511, for application between panel edges and miscellaneous sealing where butyl tape is not adequate for air tight seal.
2. Butyl Tape: 4 inch wide by 1/8 inch thick butyl tape.
3. Patch Tape: 3 inch wide roll adhesive PS.
4. Screws:
 - A) SPS Thermally Broke fastening system
 - B) Tec-4 Panel fasteners





Pacific Insulation Products

PO BOX 250
Sultan, WA. 98294
P: 1-877-300-3794
F: 1-425-905-7272

sales@pacificinsulationproducts.com

The information contained in this brochure and the accompanying material is thought to be reliable and correct, but is subject to change without notice. Pacific Insulation Products assumes no responsibility for engineering or design of any structures or sub-structure, whether such structure contains products manufactured or supplied by Pacific Insulation Products or not. Typical details are meant to show the product to the seller in a manner which is representative of the way in which they are installed. It is the responsibility of the buyer or his/her architect or engineer to verify that any product is suitable for the conditions and use intended and that the products are compatible with any material.